

# DEHOUST

## *Watermanager GWM inhouse*

Greywater treatment for re-use of process water

### Installation and commissioning manual

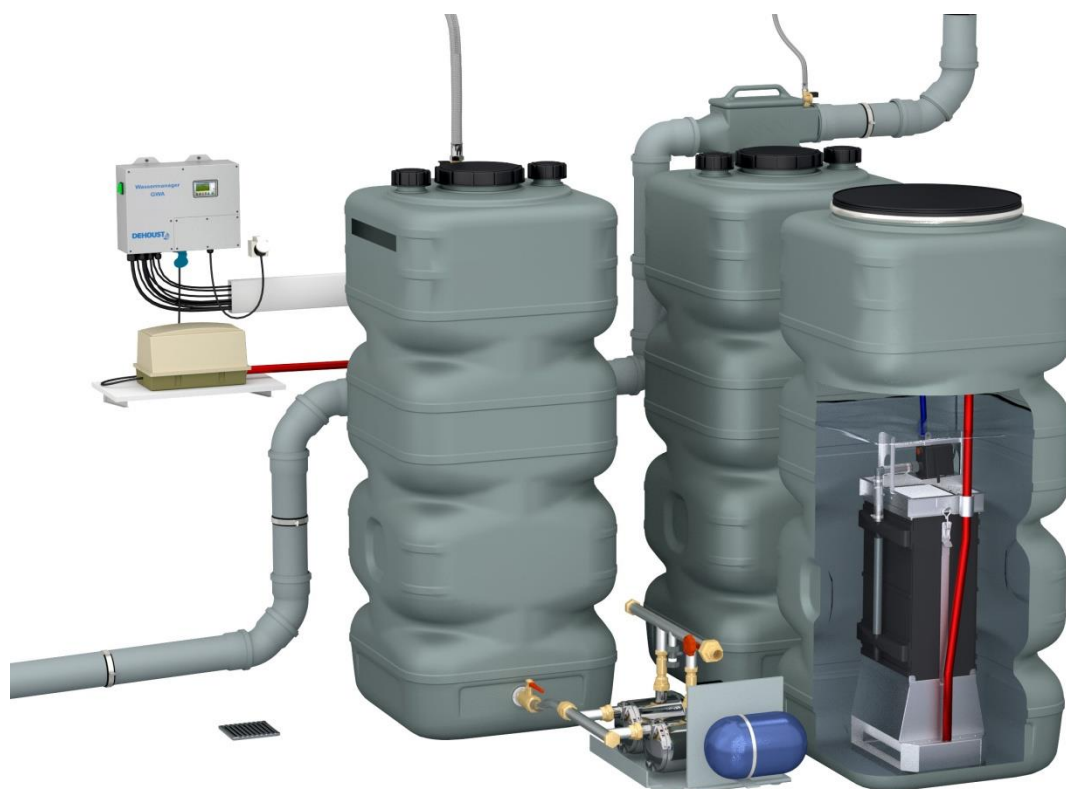

Valid from Firmware version: GWM V5\_43

Last updated: 05.06.2019

**Contents**

- 1. Safety advice.....1**
  - 1.1. Reference to other manuals..... 1
  - 1.2. Safety advice in these instructions ..... 1
  - 1.3. General safety advice ..... 1
  - 1.4. Further safety conditions ..... 2
  - 1.5. Consequences and risks of non-compliance with the manual ..... 2
  - 1.6. Duty of care of the operator ..... 2
  - 1.7. Safety advice for maintenance, inspection and assembly work..... 2
  - 1.8. Duty to register service water plants..... 3
  - 1.9. Requirements of operating personnel..... 3
  
- 2. General information.....4**
  - 2.1. Warranty and liability ..... 4
  
- 3. Description.....5**
  - 3.1. Functional description ..... 5
  - 3.2. Process water quality..... 5
  - 3.3. Technical specifications ..... 6
  - 3.4. Scope of delivery ..... 7
  - 3.5. Structure ..... 8
  - 3.6. Intended use ..... 8
  - 3.7. Improper use..... 9
  
- 4. Transport .....10**
  
- 5. Assembly.....11**
  - 5.1. Installation room ..... 11
  - 5.2. Installation of the tanks ..... 11
  - 5.3. Connection of the coarse filter..... 11
  - 5.4. Overflow of the tanks ..... 14
  - 5.5. Greywater return flow ..... 15
  - 5.6. Air compressor, filtrate lines, circulation line..... 16
  - 5.7. Drinking water feed ..... 21
  - 5.8. Process water line..... 22
  - 5.9. Emergency overflow due to Type AB drinking water feed..... 23
  - 5.10. Electrical connection..... 23
  - 5.11. Potential-free alarm output ..... 31
  - 5.12. Extern alarm input..... 32

<b>6. Commissioning</b> .....	<b>33</b>
6.1. System operation until commissioning.....	33
6.2. Step 1: commissioning to mains water – without greywater inflow .....	34
6.3. Step2: commissioning to mains water with greywater inflow .....	35
6.4. Step 3: commissioning to automatic-operation .....	35
6.5. Extended periods of downtime .....	36
<b>7. Repairs</b> .....	<b>37</b>
7.1. Inspections .....	37
7.2. Maintenance .....	38
<b>8. Errors/Troubleshooting</b> .....	<b>40</b>
8.1. Errors displayed at the control unit .....	40
8.2. Pressure surges in drinking water line .....	40
8.3. Odours in the installation room/at the consumers .....	40
<b>9. Disposal</b> .....	<b>40</b>
<b>10. Declaration of Conformity</b> .....	<b>41</b>



# 1. Safety advice

## 1.1. Reference to other manuals

For a safe and trouble-free operation of the system please pay attention to the following manuals too:

<ul style="list-style-type: none"><li>• Manual for commissioning</li><li>• Operation manual GWM</li></ul>	New-installation: operating manual GWM (according to valid firmware)
<ul style="list-style-type: none"><li>• Maintenance</li><li>• Exchange of BMT-membrane filter</li><li>• Software-Update</li></ul>	Manual BMT-membrane filter exchange and software-update.

## 1.2. Safety advice in these instructions

	Instructions labelled with this symbol provide advice on technical information and tips for usage, which should avoid any damage to the system. This symbol does not denote safety advice.
	Instructions labelled with this symbol indicate that minor bodily injury or minor material damage can occur if the precautionary measures are not heeded.
	Instructions labelled with this symbol indicate that death, severe bodily injury or considerable material damage can occur if the precautionary measures are not heeded.

## 1.3. General safety advice

This manual contains basic instructions, which should be taken into account during transportation, assembly, commissioning, operation, maintenance, storage and disposal. The valid data, operating conditions and usage conditions specified in the technical datasheet and manual must be taken into account when using the *Watermanager GWM*.

**This installation manual is valid only in association with the corresponding valid operation manual GWM.**

**After any Software-Update please consider the new corresponding operation manual for the control unit.**

- Never exceed the permitted limits of use stated in the documentation with regards pressure, temperature, etc.
- Follow all the safety advice and handling instructions in this manual.
- Instructions displayed directly on the system must be heeded and must be kept in a completely legible condition. This applies to:
  - Safety advice
  - Labels regarding connections
  - Type plate
- Before assembly and start-up, the manual must be read by the user and the responsible specialist/operator. The manual must always be available in the *Watermanager GWM*'s place of use.
- Installation and maintenance work must only be carried out by an authorised professional with suitable tools.
- The technical condition of the *Watermanager GWM* must be checked at regular intervals by the operator.
- Local safety and accident regulations must be complied with when operating the *Watermanager GWM*.
- The generally accepted rules of technology must be complied with for the assembly and operation of the appliance.
- No changes to the *Watermanager GWM* are permitted. Any changes will lead to any warranty claims being void.
- A defined or controlled restart of the process must be carried out after any interruption to the electricity or fluid supplies.
- The operator is responsible for complying with the local conditions that are not detailed in this manual.

## 1.4. Further safety conditions

As well as the safety advice listed in this manual and the proper use, the following safety conditions apply:

- Accident prevention regulations, safety and operating conditions
- Safety conditions when dealing with hazardous substances
- Valid standards and legislation, particularly the following standards: DIN EN 12056, DIN 1988, DIN 1986, DIN EN 1717, DIN EN 806.

## 1.5. Consequences and risks of non-compliance with the manual

- Non-compliance with this manual will lead to the loss of any warranty and claims for damages.
- Non-compliance can result in the following risks:
  - Danger to persons use to electrical, thermal, mechanical and chemical impacts
  - Failure of important functions of the product
  - Failure of instructed methods for maintenance and repairs
  - Danger to the environment due to the leakage of hazardous substances

## 1.6. Duty of care of the operator

The *Watermanager GWM* has been designed and constructed under whilst taking into account a risk assessment and after careful selection of the harmonised standards to be complied with and other technical specifications. This means the product conforms to the state of technical knowledge and guarantees a maximum level of safety. But this safety can only be achieved in operational practice if all the measures required for this are met. It is the *Watermanager GWM* operator's duty of care to plan these measures and check their execution. In particular, the operator must ensure that

- the *Watermanager GWM* is only used as intended.
- the *Watermanager GWM* is only operated in a flawless, functional state.
- the manual is always in a legible condition and available in its entirety at the *Watermanager GWM*'s place of use.
- only sufficiently qualified and authorised personnel assemble the *Watermanager GWM*, commission it, repair it and carry out maintenance on it.
- these personnel are regularly instructed in all the relevant issues of occupational safety and environmental protection, as well as ensuring that they have read and understood the manual and, specifically, the safety advice contained therein.
- none of the safety and warning signs attached to the *Watermanager GWM* are removed and that all remain in a legible state.
- any additional risks which arise due to the specific working conditions at the place of use of the *Watermanager GWM* are recognised as part of a risk assessment (in the sense of the German Occupational Safety and Health Act § 5 or the equivalent legislation in the country of use).
- all additional instructions and safety advice arising from the risk assessment are compiled in a user guide (in the sense of German Work Equipment Usage Ordinance § 6 or the equivalent legislation in the country of use).
- the duct routing is dimensioned sufficiently.

## 1.7. Safety advice for maintenance, inspection and assembly work

- The machine may only be altered or modified with the consent of the manufacturer.
- Only use original parts or those authorised by the manufacturer. Using other parts can void your warranty for any consequences resulting there from.

- Only work on the machine when it is turned off.
- The parts of the system must be at the ambient temperature.
- Ensure the inspection/maintenance procedures described in the manual are complied with exactly.
- Reattach or restart any safety and protection equipment immediately after work has been completed. Before restarting the equipment, ensure the listed points for start-up have been taken into account.
- Keep any unauthorised persons (e.g. children) away from the system.

## **1.8. Duty to register service water plants**

All service water plants must be registered when started up or decommissioned in the Federal Republic of Germany. Check your duty to register in accordance with the country-specific regulations, standards and legislation concerning service water plants.

## **1.9. Requirements of operating personnel**

The *Watermanager GWM* must only be assembled, commissioned, repaired and decommissioned by persons who have been trained, instructed and authorised for this purpose. If necessary, training can be provided the manufacturer/supplier at the request of the operator. Training sessions for the system must only be carried out under the supervision of technical professionals. The relevant authorisations of personnel must be clearly specified by the operator in the form of a user guide. In addition, special qualifications are required for the following activities:

- Work on the electrical equipment must only be carried out by trained electricians.
- Assembly, maintenance and repair work must only be carried out by qualified professionals.

The basic regulations for occupational safety and accident prevention must be heeded.

## 2. General information

The manual is part of the specified series and its models. The manual describes the proper and safe use of the equipment in all operating phases. The type plate states the series and size, the most important operational data and the serial number. To maintain any warranty claims in the case of damage, the authorised dealer must be notified immediately with information of the installation site and serial number of the machine.

### 2.1. Warranty and liability

The general delivery conditions and terms of sale of DEHOUST shall apply. Any warranty and liability claims for personal or material damage are void if they can be attributed to one or more of the following causes.

- Improper use of the *Watermanager GWM*
- Improper assembly, commissioning, operation and maintenance of the *Watermanager GWM*
- Non-compliance with the instructions in the manual regarding transportation, storage, assembly, commissioning, operation, maintenance and repair of the *Watermanager GWM*
- Unauthorised structural modifications to the *Watermanager GWM*
- Improperly executed repairs
- Disasters caused by third party exposure and forces majeures.

### 3. Description

Using *BioMembranTechnologie*, the *Watermanager GWM* treats domestic greywater from baths, showers and basins to produce high-quality process water for a second purpose as process water.

#### 3.1. Functional description

The separately collected greywater is initially relieved of any insoluble substances contained in it, such as hair, textile fluff, etc., using the *Trident* coarse filter. This coarse filter is automatically back-flushed and cleaned periodically. Subsequently, the control unit ensures all biodegradable substances contained in the water, such as shower gel, shampoo, soap, etc. are broken down by micro-organisms in the *Watermanager GWM*. To do this, the greywater is circulated periodically between the greywater buffer tank and the BMT unit in order to create a consistent oxygen supply for biodegradable processes. The BMT membrane filter, the heart of the BMT unit, performs the last treatment process. By applying a low pressure, the water is gently drawn through the filter membranes into the process water storage tank. The permanently physical barriers of the BMT membrane filter with just a 38 nm pore width guarantees secure separation of particles, sludge, germs and adsorbed viruses from the greywater: the result is absolutely clear, odour-neutral and germ-free process water. The cleaned greywater can be stored for a long time and reused with no hygienic hesitations due to the very low nutrient content (biological cleaning) and virtually undetectable remaining biomass (ultrafiltration). If there is no process water available, the *Watermanager GWM* automatically switches to drinking water operation. If needed, drinking water is automatically feed into the process water storage tank in accordance with DIN EN 1717 (AB).

All unit processes are micro-electronically monitored by the central control unit and managed in a fully-automated manner. Faults are shown by a visual or acoustic message and can be sent by SMS or email to a mobile telephone or central control room via an optional GSM modem (available as an optional accessory). It is also possible to connect a potential-free alarm contact to a standard connection.

#### 3.2. Process water quality

The **process water does not have the quality of drinking water**, but is many times below the hygienic, microbiological requirements of the British Standard 8525-1 for greywater usage, the EU Bathing Water Directive 2006/7/EC (2006) and the requirements of Irrigation Classification 2 (public parks, school sports facilities) in accordance with DIN 19650 (1999). This high-quality process water can be used without any hygienic qualms for any purposes in the field of process water usage.

**Table 1: Outflow qualities of process water after treatment by Watermanager GWM**

Parameter	Outflow quality*
Biological oxygen demand (BOD <sub>5</sub> )	< 5 mg/L
Chemical oxygen demand (CSB)	< 20 mg/L
TS (dry solids)	< 1 mg/L
Turbidity	< 1 NTU
Escherichia coli	0 cfu/100ml
Total coliforms	< 10 cfu/100ml

\* greywater feed quality from showers, bath tubs, washbasins as per fbr information sheet H201 (2005) Table 1.



### 3.3. Technical specifications

**Table 2: Technical details of the standard Watermanager GWM\***

Description	GWM 950	GWM 1.150	GWM 2.000	GWM 3.000	GWM 6.000	GWM 9.000	GWM 12.000	GWM 15.000
Item number	813345	813355	813365	813375	813385	813395	813605	813615
Treatment capacity [litre/day]	950	1.150	2.000	3.000	6.000	9.000	12.000	15.000
Greywater inlet / overflow	DN 100				DN 150			
Process water overflow	DN 100							
Greywater buffer tank [litre]	500	600	1.700	2.500	5.000	7.500	10.000	12.500
Process water storage tank [litre]	500	600	1.500	2.200	4.000	6.000	8.000	10.000
Connection of coarse filter back-flush	1/2" female				1" female			
Drinking water pipe connection	1 1/2" female (max. 22,3 m <sup>3</sup> /h at 5 bar)							
Process water pipe connection (depending on pressure increase)	1 1/2" female							
Flow pressure of coarse filter back-flush / drinking water feed	min. 1 bar; max. 5 bar							
Ambient temperature	15°C to 25°C							
Mains voltage	230 V AC, 50 Hz, 16 A							
Power consumption without pressure increase [watt]	450				600	750	900	1.050
Empty weight [kg]	140	160	330	440	890	1.295	1.700	2.170

\*All shown details may vary depending to specific project details.

### 3.4. Scope of delivery

Pre-assembled *Watermanager GWM*, consisting of:

- *Trident* coarse filter
- Greywater buffer tank(s)
- BMT unit(s)
- Process water storage tank(s) with integrated drinking water feed facility as per DIN EN 1717 type AB
- Control unit
- *BMT-Manager Indoor* switchbox
- Air compressor with wall bracket
- Plastic bag with activated carbon and dried bacteria culture for initial inoculation
- Assembly accessories
- Hose connectors
- Documentation folder
  - Operating instructions
  - Specific set-up diagram
  - Packing note
  - Safety data sheet
- Optional: Pressure booster pump station



Depending on the model type, various storage tanks can be used. Please see the packing note of the *Watermanager GWM* and the set-up diagram of the entire system provided in the delivery.

### 3.5. Structure

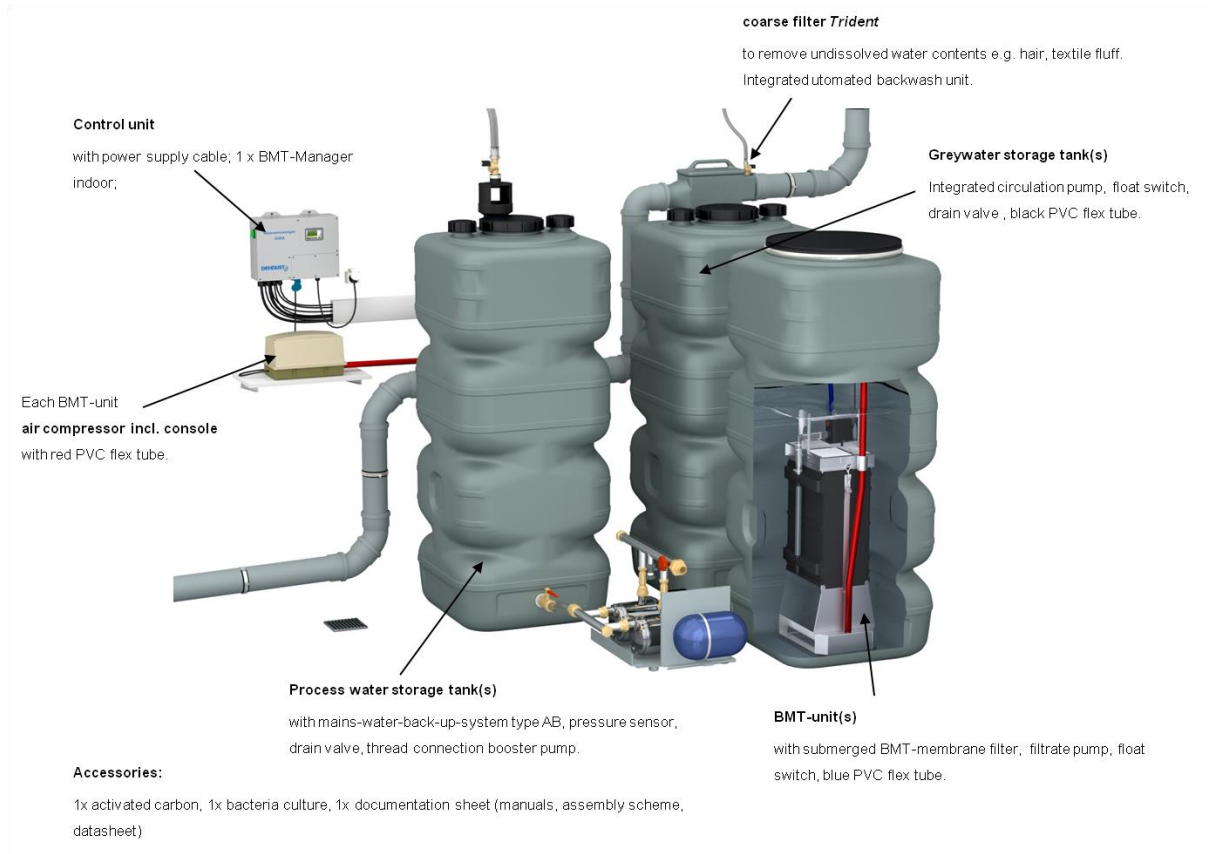

Figure 1: Principle structure of the Watermanager GWM



The actual system may deviate from the basic set-up. Please see specific set-up diagram!

### 3.6. Intended use

The *Watermanager GWM* must only be operated in those fields of use described in this manual. Risks for people, surrounding systems and the environment may arise if the *Watermanager GWM* is used improperly.

- Only operate the *Watermanager GWM* in a technically flawless state.
- Do not operate the *Watermanager GWM* in a partially assembled state.
- The *Watermanager GWM* is used to treat slightly contaminated domestic wastewater from showers, bathtubs and washbasins.
- The *Watermanager GWM* may be operated up to a maximum water temperature of 40°C.
- Heed the information concerning maximum flow rates and pressures (see chapter 3.2) (avoidance of overheating, damage to mechanical seals, damage to cavitations, storage damage, ...).
- Do not restrict the drinking water feed of the *Watermanager GWM* on the input side (avoidance of cavitation damage, dry running of pressure booster).
- Agree alternative operational modes, if not stated in the documentation, with the manufacturer.

### 3.7. Improper use

The *Watermanager GWM* is not intended for outdoor use. Influences of temperature, light and moisture can lead to functional disturbances and damage to the equipment.

- Do not use the *Watermanager GWM* outside.
- Only use the *Watermanager GWM* as intended.
- *Watermanager GWM* is not permitted for cleaning of
  - Industrial wastewater
  - Extremely contaminated wastewater from kitchens
  - Wastewater containing faeces
  - Wastewater from washing machines
  - Wastewater from dishwashers
  - Dyed wastewater (e.g. paint residue, textile and hair dye)
  - Contaminated wastewater (e.g. concentrated lyes and acids, medical mud baths, pharmaceuticals/medication, foaming water additives, silicones, resins, solvents, colouring agents, flocculants)
- Do not fill the media utilities of the system with flammable media.
- Do not put the casing and tank under mechanical strain (e.g. by stacking objects on them or using them as steps).
- Do not make any external changes to the equipment casing and tanks. Casing components and screws must not be painted!
- Do not disassemble the *Watermanager GWM* beyond the level required for installation and maintenance.

## **4. Transport**



The product is delivered on several pallets. During transportation, you must ensure that the components are not knocked and thrown about. All pallets/components must be stored in a dry, cold room protected from both sunlight and frost.

When delivering goods, check every packing unit for damage. In case of transport damage, determine the exact damage, document it and report it immediately in writing to the contracting party or DEHOUST.

## 5. Assembly

### 5.1. Installation room

The *Watermanager GWM* must be installed at ground level and horizontally in a frost-free, dry and well-ventilated room. The load bearing capacity of the floor must be at least the total weight of the *Watermanager GWM* in its filled operating state (750 kg/m<sup>2</sup>). The room temperature must not exceed the maximum permitted temperature (see 3.3) to minimise hygienic risks in the process water storage tank. A minimum clearance between the tank lids and room ceiling of at least 500 mm must be ensured for maintenance and inspection purposes.

	Do not operate the <i>Watermanager GWM</i> near living rooms or bedrooms due to the noise caused by air compressors, feed units and pumps.
	Pay attention to the space requirements for operation and repairs.
	The installation room must have a suitable floor drain/sump to securely drain away the overflowing water in case of back-flooding over the free emergency spillway of the supply tank.

### 5.2. Installation of the tanks

The tanks should be installed on the basis of the separate set-up diagram. Each individual tank is labelled and marked accordingly.

	Ensure that all tanks are installed at the same level to avoid any malfunctions during the system operation.
-------------------------------------------------------------------------------------	--------------------------------------------------------------------------------------------------------------

### 5.3. Connection of the coarse filter

#### 5.3.1. Inlet and overflow

The connection sizes of the coarse filter can be found in the specifications (see 3.3). Before it can be connected with the coarse filter inlet, the greywater line must **have at least a 500 mm horizontal inlet line**. The connection of the greywater downpipe with the coarse filter should be done after all construction works inside the building are finished. The overflow connection of the coarse filter must be connected to the drain at a sufficient incline. The coarse filter drain must be connected with the inlet of the greywater buffer tank firmly, tightly and in a de-energised state.

The coarse filter inlet is designed as standard as a connecting sleeve, with the drains to the sewer and greywater buffer tank being smooth pipe connections.

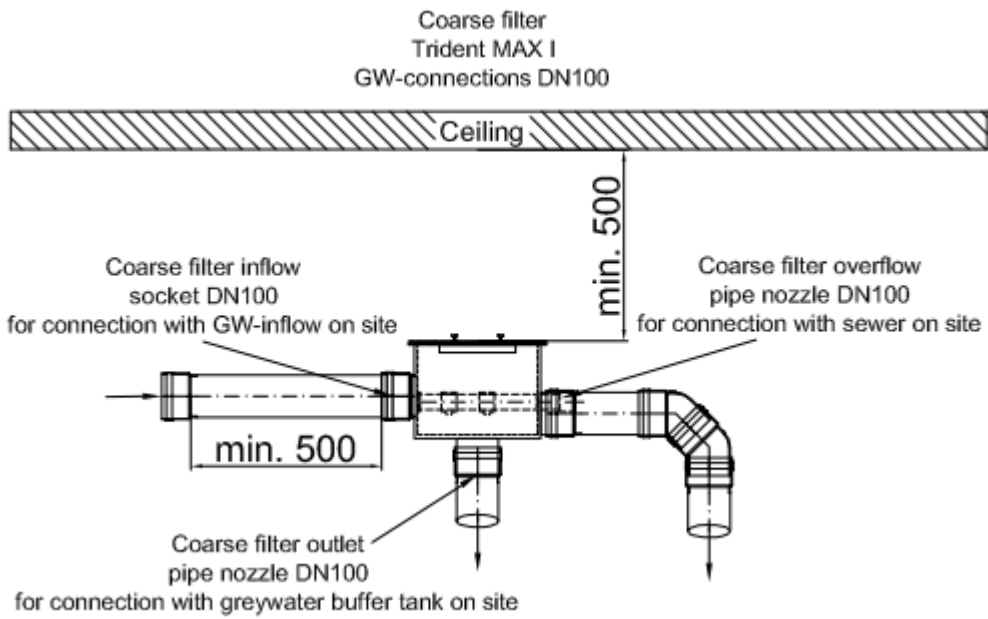

Figure 2: Connection of the coarse filter Trident MAX I

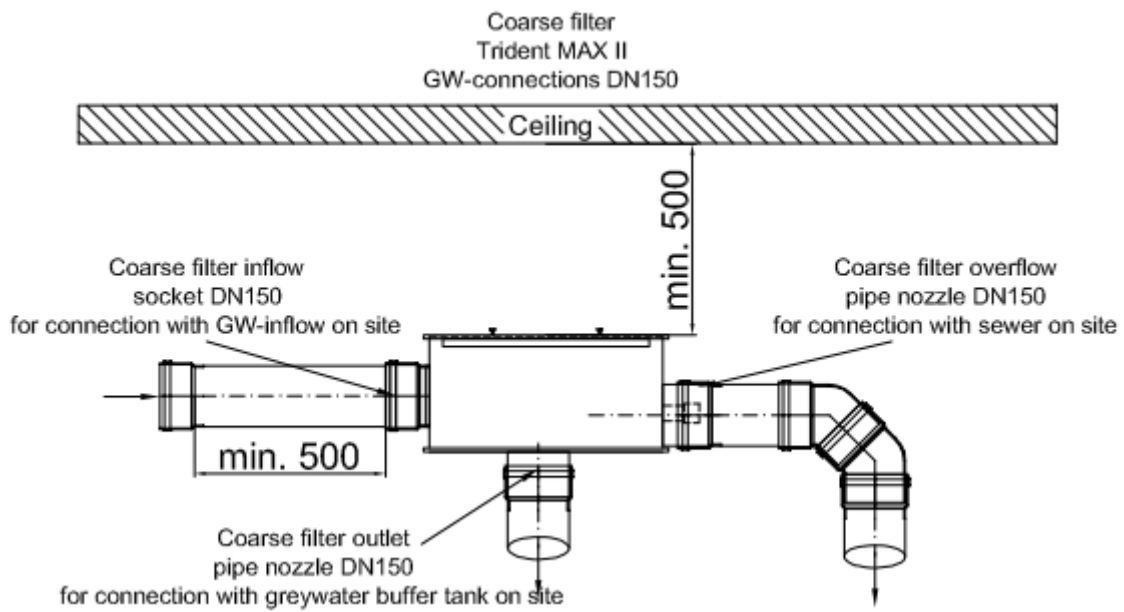

Figure 3: Connection of coarse filter Trident MAX II



Make sure the overflow line to the sewer/pumping system has the same nominal width as the overflow connection (no cross-section constriction!).

### 5.3.2. Backflushing line of the coarse filter

Connect the back-flushing line (see 3.3) firmly, tightly and in a de-energised state with a branch line of the **process water line**.

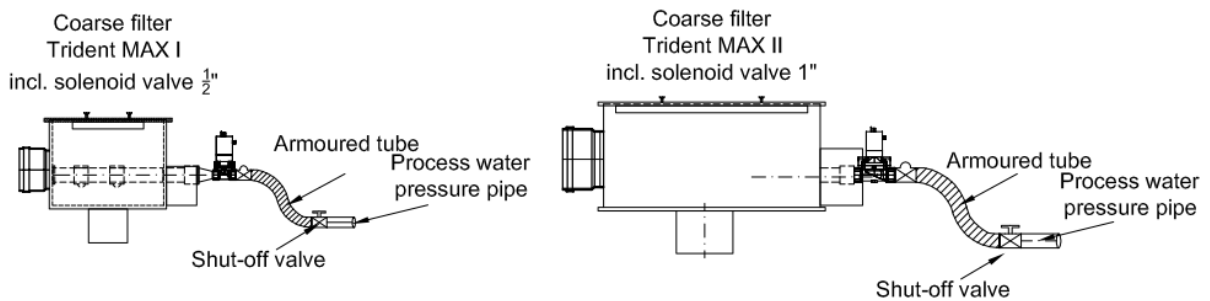

Figure 4: Connection of the backflushing line of coarse filter MAX I and MAX II

	<p>We recommend installing a shut-off valve and a detachable screw.</p>
	<p>The flow pressure to the back-flushing line must conform to the specifications (see 3.3).</p>



### 5.4. Overflow of the tanks

The overflow connections of the coarse filter and those of the greywater and process water storage tanks are designed to be flat pipe connections and must be connected with the drain. You must ensure that no greywater can flow into the process water storage tank when connecting the overflow connections from the greywater and process water storage tanks with the drain.

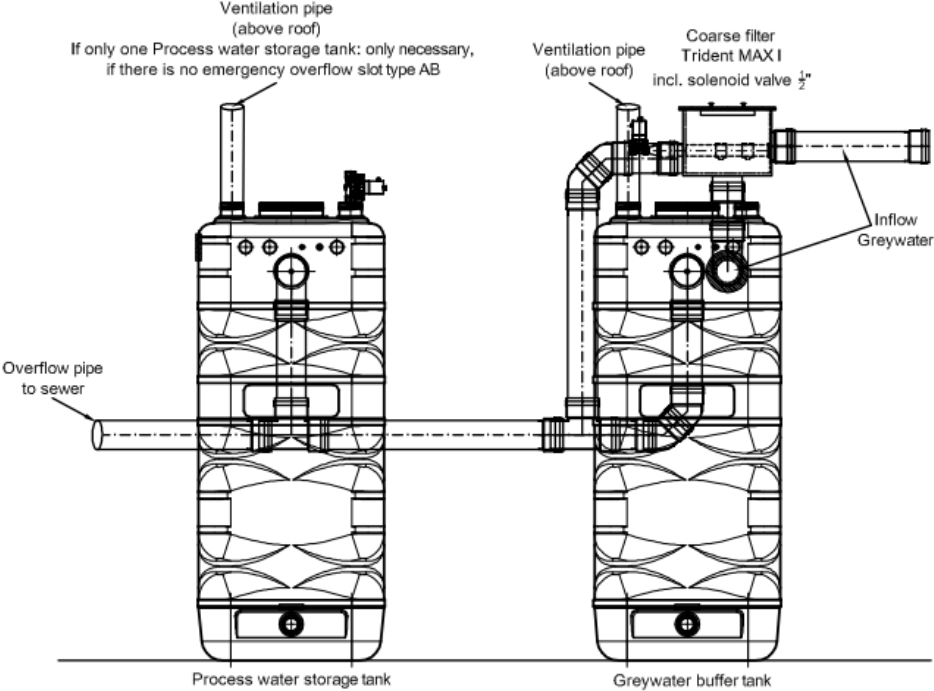

Figure 5: Connection of the overflows at AQF-tanks

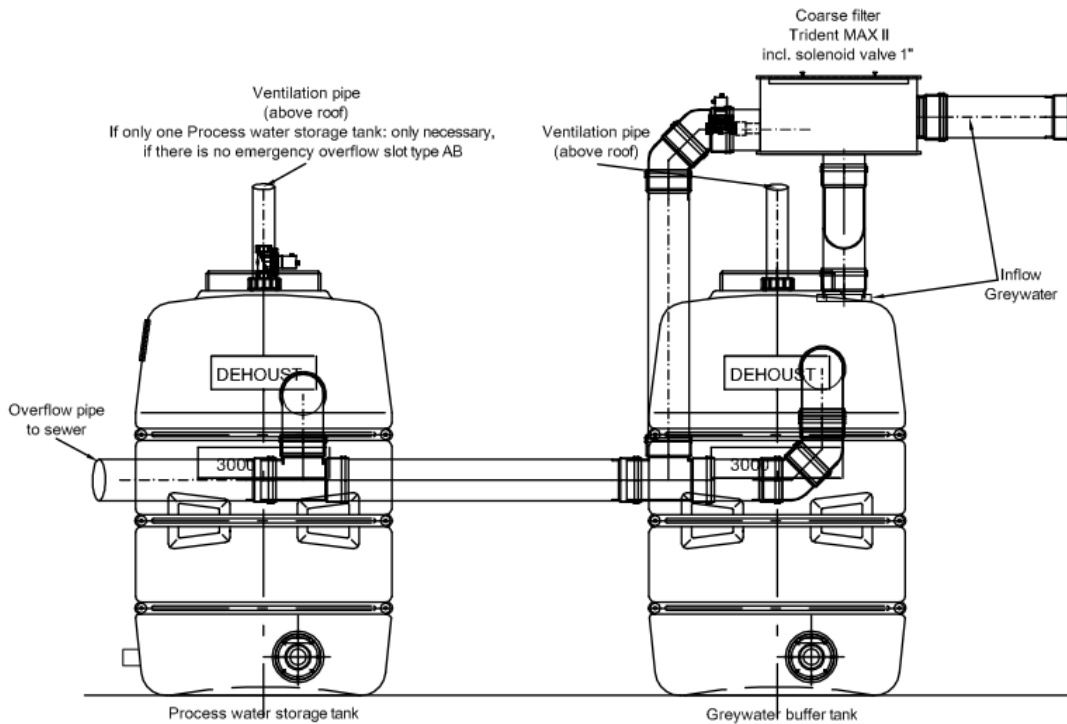

Figure 6: Connection of overflows at DF-tanks



<b>i</b>	We recommend installing a separate ventilation line for the greywater buffer tank. Each greywater buffer tank has a 2" female tank screw available for this reason.
<b>i</b>	We recommend installing a siphon in the drain overflow to avoid any bad smells.
<b>!</b>	The drain connection or pump system must be able to securely drain the maximum drinking water feed volume (see 3.3).
<b>!</b>	Make sure the overflow line to the sewer/pumping system has the same nominal width as the overflow connection (no cross-section constriction!).
<b>!</b>	The installation room is at risk of flooding if the overflow connection is not attached to the drain.

## 5.5. Greywater return flow

The greywater is circulated between the greywater buffer tank and the BMT unit periodically during operation. A greywater return flow line is needed for this reason between the greywater buffer tank and the BMT unit.

Connect the DN 100 pipe connection of the BMT unit with the relevant DN 100 lip seal on the greywater buffer tank using the on-site HT DN 100 pipe.

If several BMT units are connected, the DN 100 pipe connection of the BMT unit must initially be connected with the lip seal of the next BMT unit using a HT DN 100 pipe.

	Make sure the return flow line to the greywater buffer tank/BMT unit has the same nominal width as the overflow connection (no cross-section constriction!).
	Incline between the BMT unit and greywater buffer tank must be at least 1%. Otherwise there is a risk of back pressure and the tank may overflow.
	If installation of greywater return flow is not possible please consult as early as possible your contractual partner or DEHOUST. It is possible to run the Watermanager GWM as a batch-filling-system or/and to pump the circulating greywater back into the greywater buffer tank with a special Back-Tank-Solution.

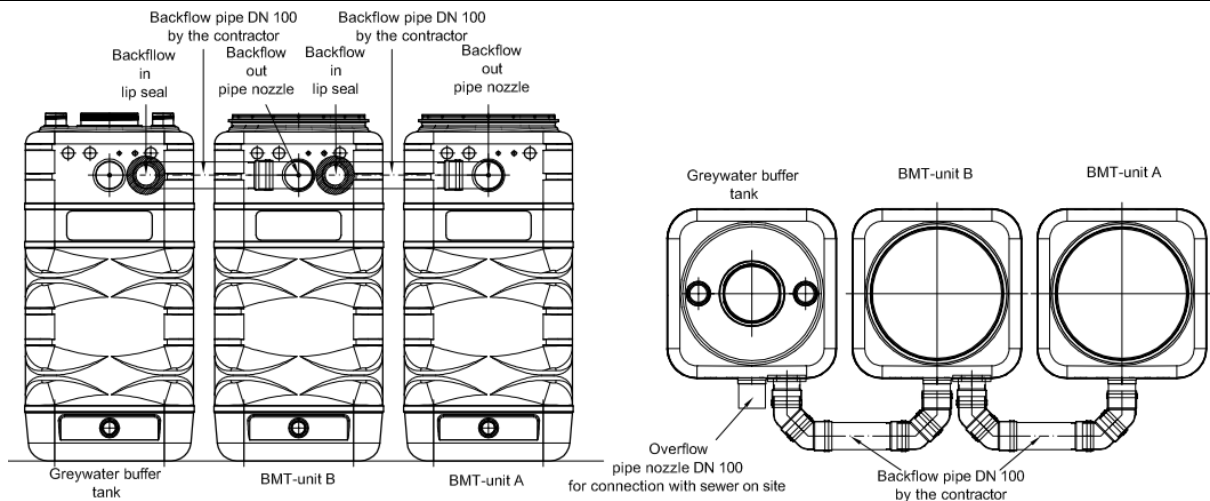

Figure 7: Connection of the greywater return flow

## 5.6. Air compressor, filtrate lines, circulation line

Connect the appropriately marked tank connections firmly, tightly and in a de-energised state using the supplied PVC hoses and the preassembled PP hose nozzles.

Connection	Tank	Connection width at tank	Material	Colour
Circulation pump 180	GWS -> BMT A	1" male thread	PVC-flex tube ø25 mm	Black
Circulation pump 600	GWS -> BMT A	1 ¼" male thread	PVC-flex tube ø32 mm	Black
Air compressor	AC -> BMT	¾" mal thread	PVC-flex tube ø19 mm	Red
Filtrate effluent	BMT -> BWS	¾" male thread	PVC-flex tube ø13 mm	blue

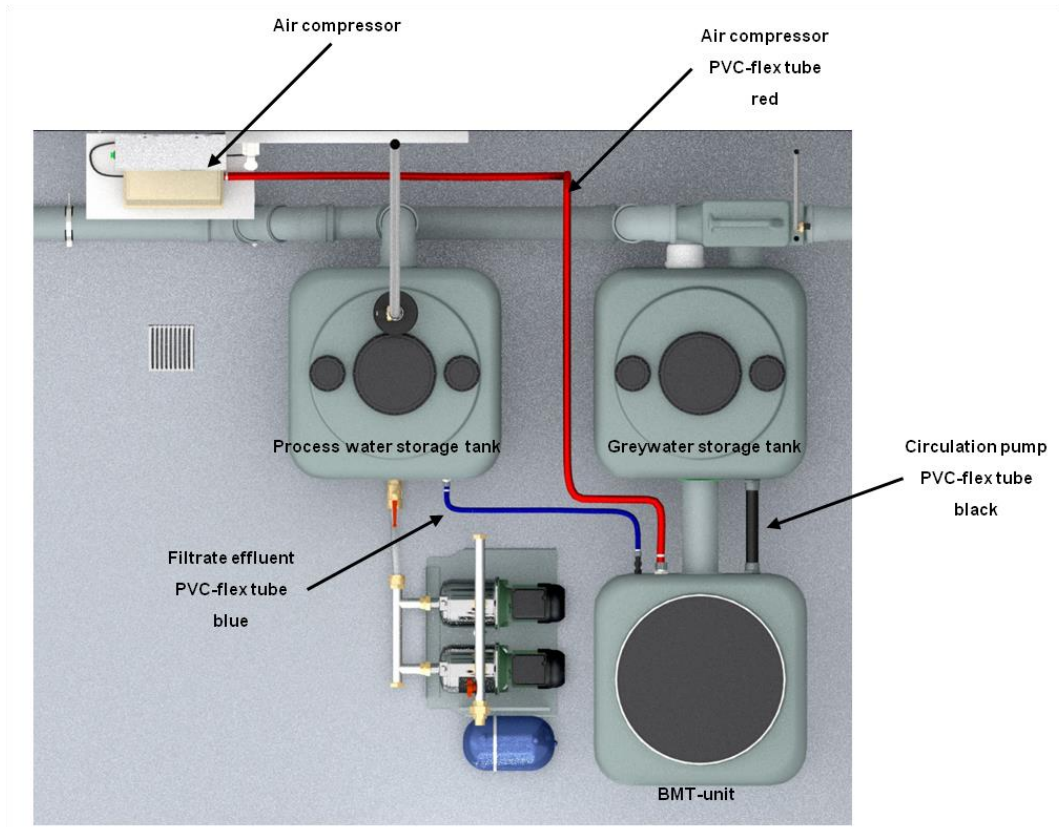

Figure 8: Connect hose lines for ventilation, circulation and filtrate

	<p>When installing the PVC hoses, ensure that there are no constrictions/kinks, which can prevent the free flow of water and air.</p>
	<p>The BMT unit(s) must not be higher than the process water storage tank when filtrate inflow shall be provided by gravity.</p>

### 5.6.1. Installation of Air compressor

Place each air compressor on the top of the corresponding BMT-unit or next to the BMT-unit by using the bracket.

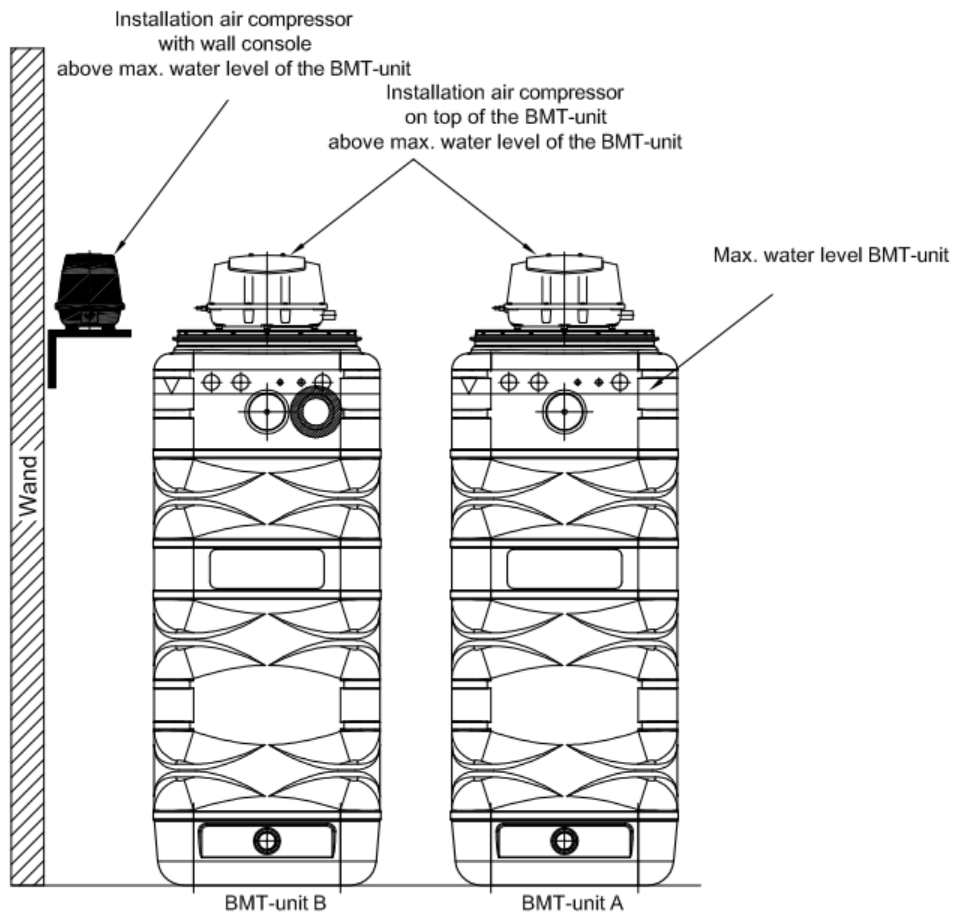

Figure 9: Installation of the air compressor

	The air compressor must be fitted above the max. water level of the BMT unit.
	Please ensure that all four feet of the air compressor are placed solidly on the bracket.

### 5.6.2. Installation of filtrate flex tube with on-site process water storage tank

If an on-site process water storage tank is used please connect the filtrate flex tube according these two possibilities:

Possibility 1:

The filtrate control box (FCB) are pre-mounted directly at a BMT-unit by using a DN 80 downpipe (inner diameter 80mm). Please connect this DN 80 port with sufficient decline to your on-site process water storage tank/cistern.

Connection  
for filtrate hoses with the filtrate control box (FÜB)  
if the BWS-tank isn't part of Dehoust delivery

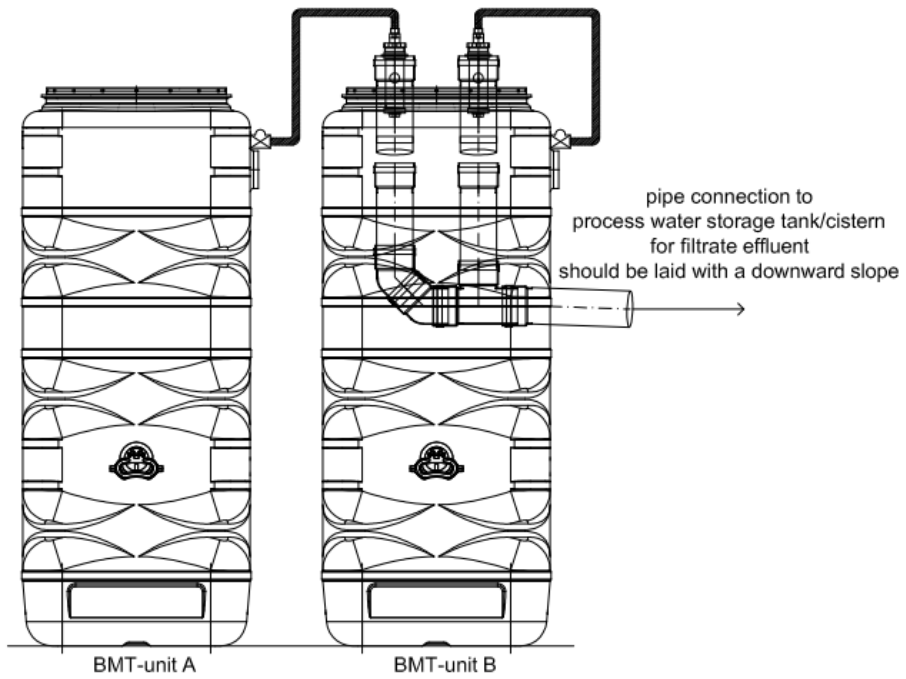

Figure 10: Connection of filtrate flex tube via FCB to on-site process water storage tank/cistern

	<p>Take care that the DN 80 downpipe to the on-site storage tank/cistern has sufficient decline.</p>
	<p>Take care that no backwater can come through the on-site storage tank/cistern into the filtrate control box (FCB).</p>

Possibility 2:

The filtrate control box (FCB) will be installed into a DN 80 port connection (inner diameter 80 mm) on the top of the process water storage tank/cistern.

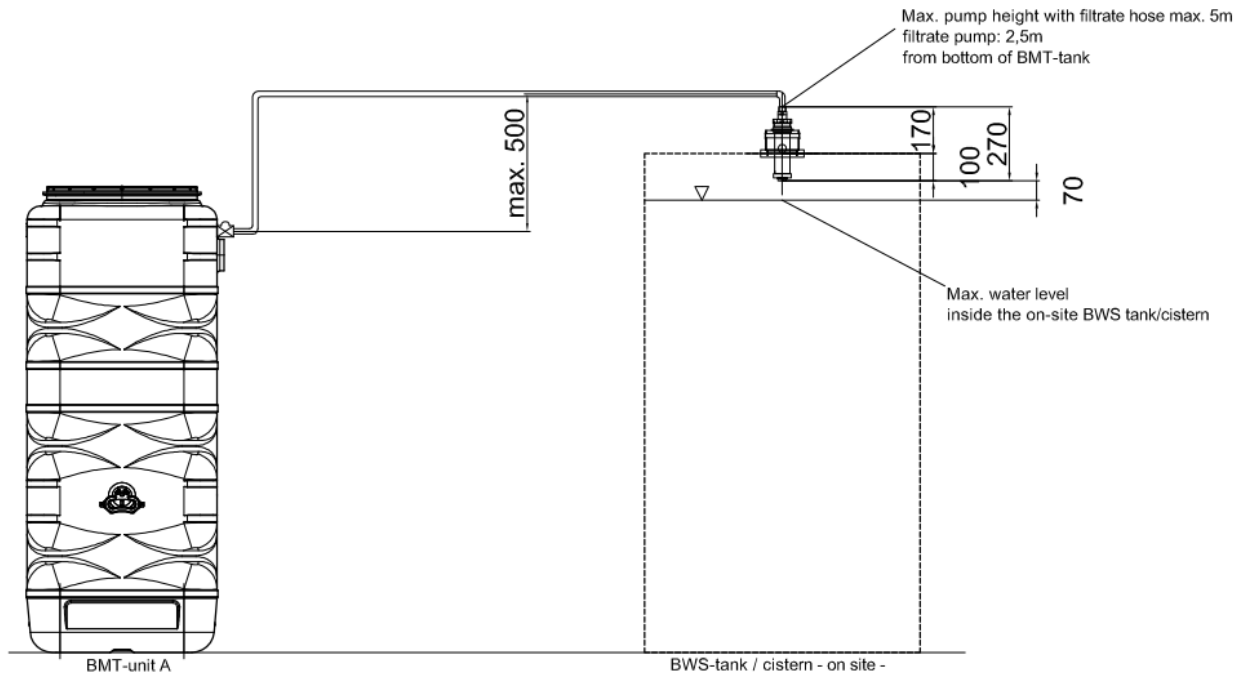

Figure 11: Connection of filtrate flex tube via FCB directly at the top of on-site process water storage tank/cistern

	<p>Take care that at least 70 mm free space between filtrate control box (FCB) and maximum water level in the storage tank is guaranteed all time and under all operating conditions.</p>
	<p>Take care that the maximum height difference of 500mm between filtrate effluent at BMT-unit and FCB is guaranteed.</p>
	<p>When installing the PVC hoses, ensure that there are no constrictions/kinks, which can prevent the free flow of water.</p>
	<p>Take care of using the correct PP-lipp-seals when installing the PVC hoses.</p>
	<p>The BMT unit(s) must not be higher than the process water storage tank when filtrate inflow shall be provided by gravity.</p>

## 5.7. Drinking water feed

Connect and seal the drinking water line with the solenoid valve of the drinking water feed (see 3.3) of the *Watermanager GWM*. Only use materials certified for drinking water installations here.

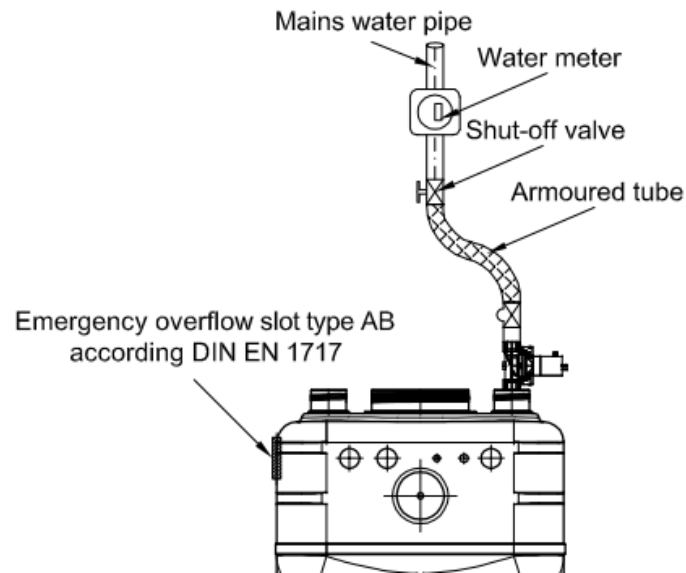

Figure 12: Connection of the drinking water feed

	<p>Connect the line in a de-energised state. No forces must be applied to the connecting sleeves and system. Install a pressure reduced in front of the system if necessary so it is guaranteed that no more than 5 bar of primary pressure is fed in from the drinking water network. We recommend installing a shut-off valve, a detachable screw and an external fine water filter.</p>
	<p>We recommend installing a cold water meter.</p>
	<p>The feed volumes of the drinking water feed must be within the range of the stated flow pressure (see 3.3) in order to guarantee long-term security of supply of the pressure booster with sufficient water guarantees.</p>



## 5.8. Process water line

Connect and seal the process water line/suction line of the pressure booster with the threaded sleeve connection (see 3.3) of the *Watermanager GWM*.

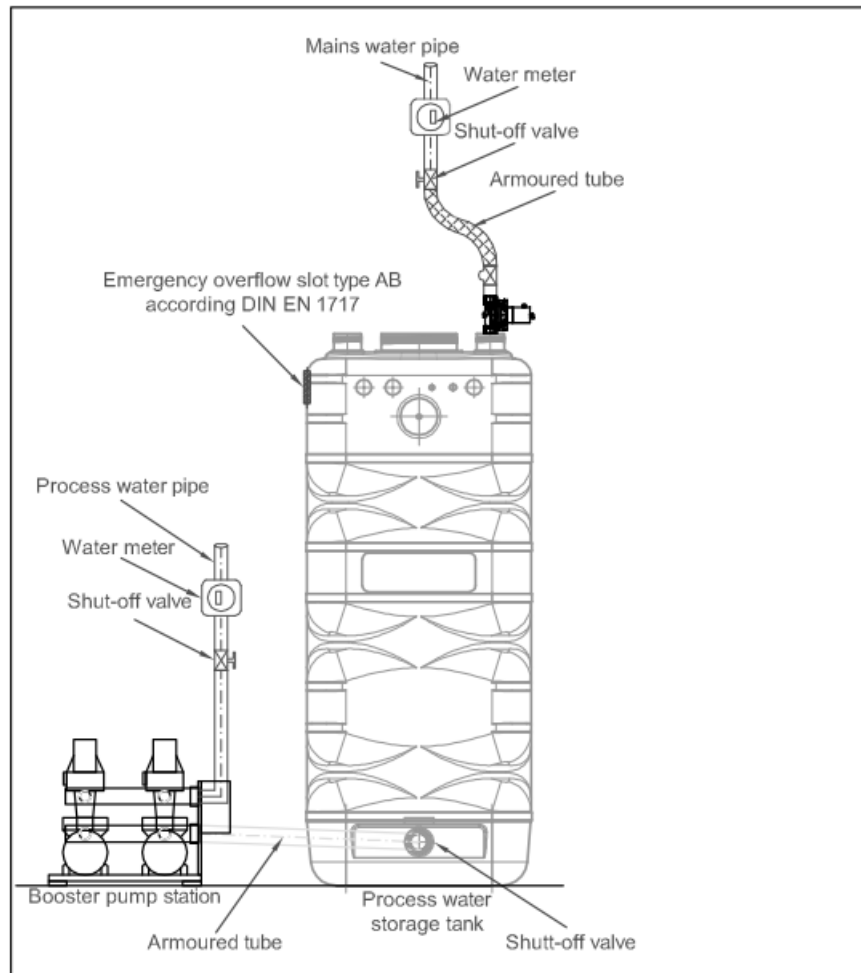





Figure 13: Connection of the process water pipe

	<p>Connect the suction line in a de-energised state. No forces must be applied to the threaded sleeve connection of the system. We recommend installing a shut-off valve and a detachable screw.</p>
	<p>We recommend installing a cold water meter in the pressure line.</p>
	<p>We recommend to install an expansion vessel in the pressure line after the booster pump station.</p>
	<p>Heed the installation manual for the pressure booster pump as well!</p>

## 5.9. Emergency overflow due to Type AB drinking water feed

If a backflow occurs due to a drain blockage/defect of the lift pumping station, reaching into the process water storage tank of the *Watermanager GWM*, the water is drained through the side emergency overflow slit of the process water storage tank into the installation room. This free overflow is required to protect the drinking water line in accordance with DIN EN 1717.



Figure 14: Type AB emergency overflow



	<p>The installation room must have a suitable floor drain/sump to securely drain away the overflowing water in case of back-flooding via the emergency overflow slit.</p>
------------------------------------------------------------------------------------	---------------------------------------------------------------------------------------------------------------------------------------------------------------------------

## 5.10. Electrical connection

All electrical components of the *Watermanager GWM* are wired and equipped with plugs during production. Attach the control unit and BMT Manager indoor to a suitable concrete wall in direct proximity to the tanks using the supplied assembly accessories. Make all electrical connections in accordance with the diagrams below. Ensure that the screws are positioned correctly and tightened well.

Check the information about the mains voltage on the type label with the mains voltage in question.

Only plug the socket of the control unit into a plug when the system is being put into operation (see 6).

	<p>The electrical system must conform to the general requirements for installation IEC 364 / VDE 0100, i.e. sockets with earthing terminals. The electrical network, onto which the equipment is connected, must have a residual current operated circuit breaker (RCCB) in accordance with DIN EN 60335-2-41 / VDE 0700.</p>
	<p>Always connect other external energy consumers (e.g. pressure boosters) to a separate voltage source.</p>

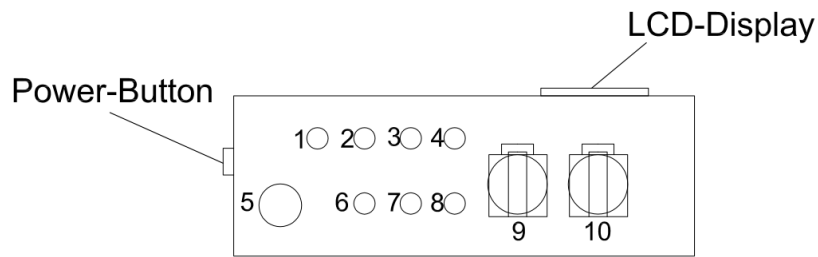

Figure 15: electrical connections at the bottom side of the control unit

1	20X4	Circulation pump greywater
2	20X5	Float switch GWSmax (greywater)
3	21X3	Mainswater feed
4	21X2	Coarse filter backwash
5	20X1	BMT-Indoor-Manager
6	21X1	BWS-Manager (filtrate control box (FCB) + level sensor process water tank)
7		Power supply (fix pre-mounted)
8	20X9	Cable connection for potential free alarm output/external alarm input (see chapter 5.11 and 0)
9	20X7	External greywater aeration (only in association with optional equipment)
10	21X7	Feed pump rainwater (only in association with optional equipment) Auto-Drainage-System (only in association with optional equipment)

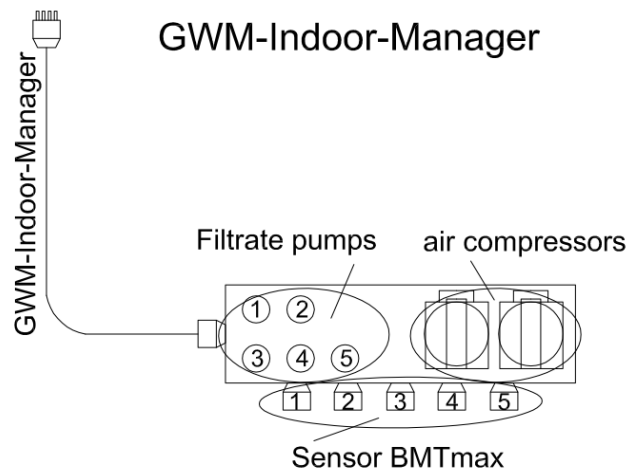

Figure 16: electrical connections at the GWM-Indoor-Manager

**5.10.1. Electrical connection of coarse filter, greywater and process water storage tank**

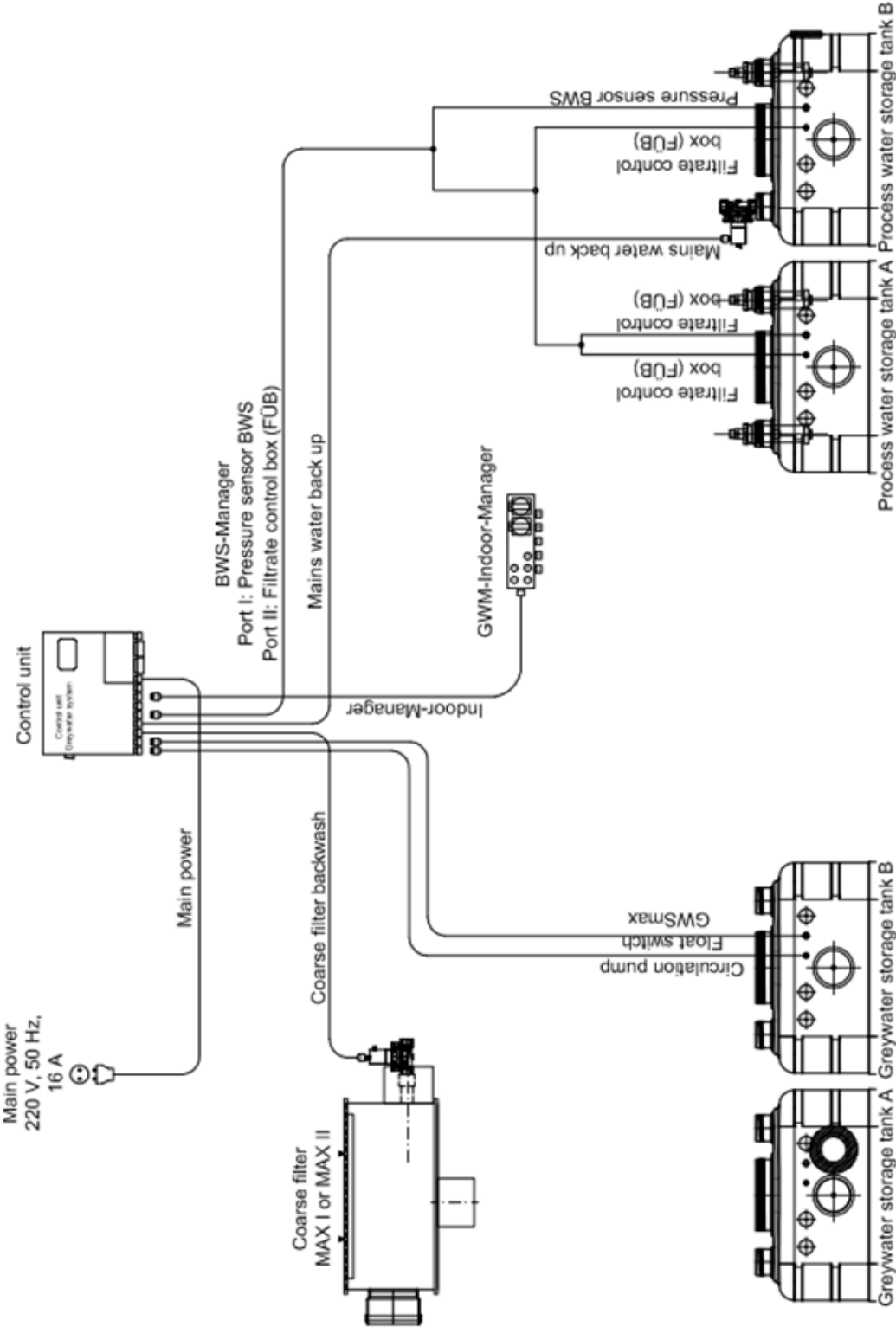

Figure 17: Electrical connection of coarse filter, greywater buffer tank and process water storage tank

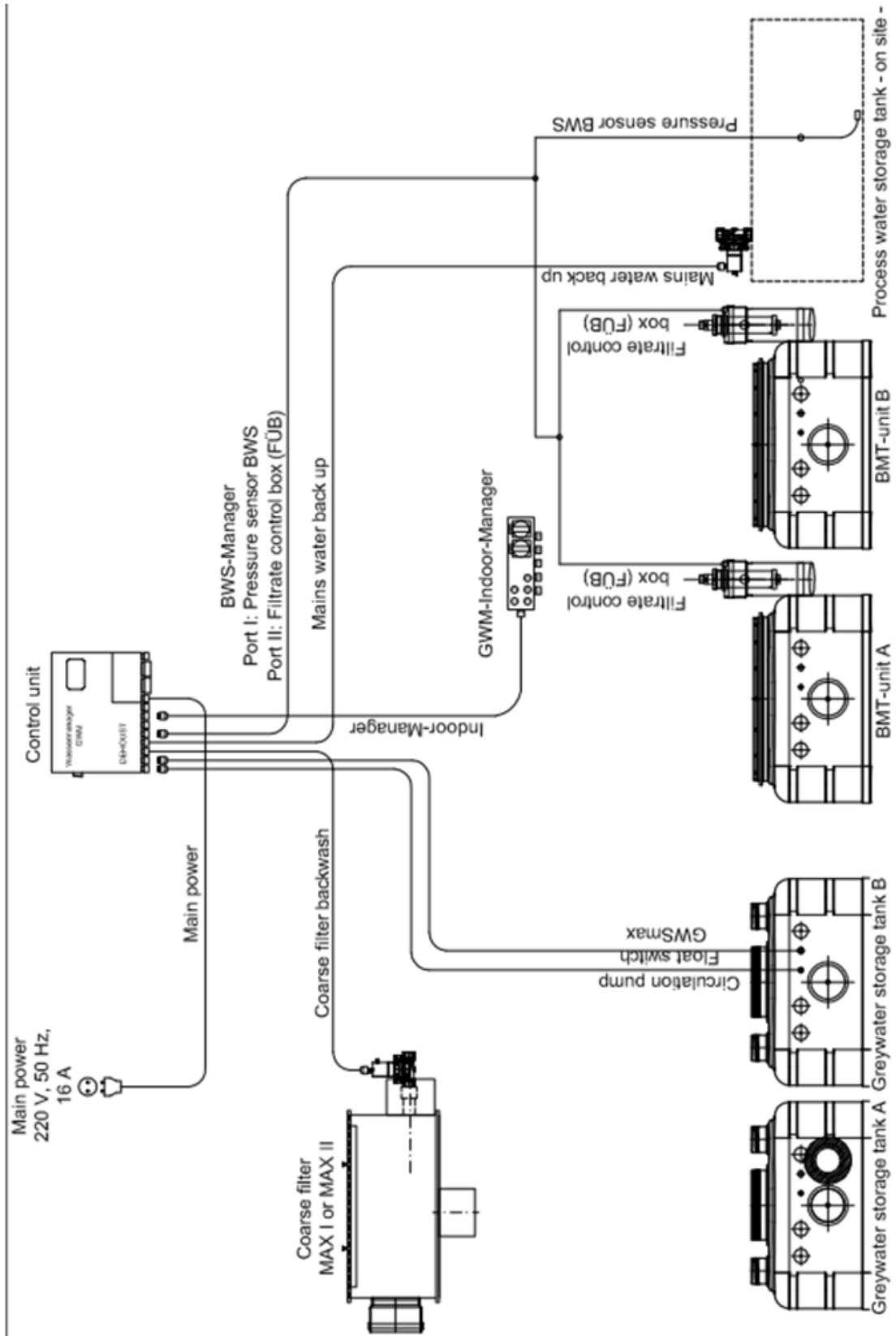

Figure 18: Electrical connection of coarse filter, greywater buffer tank and on-site process water storage tank (possibility 1)

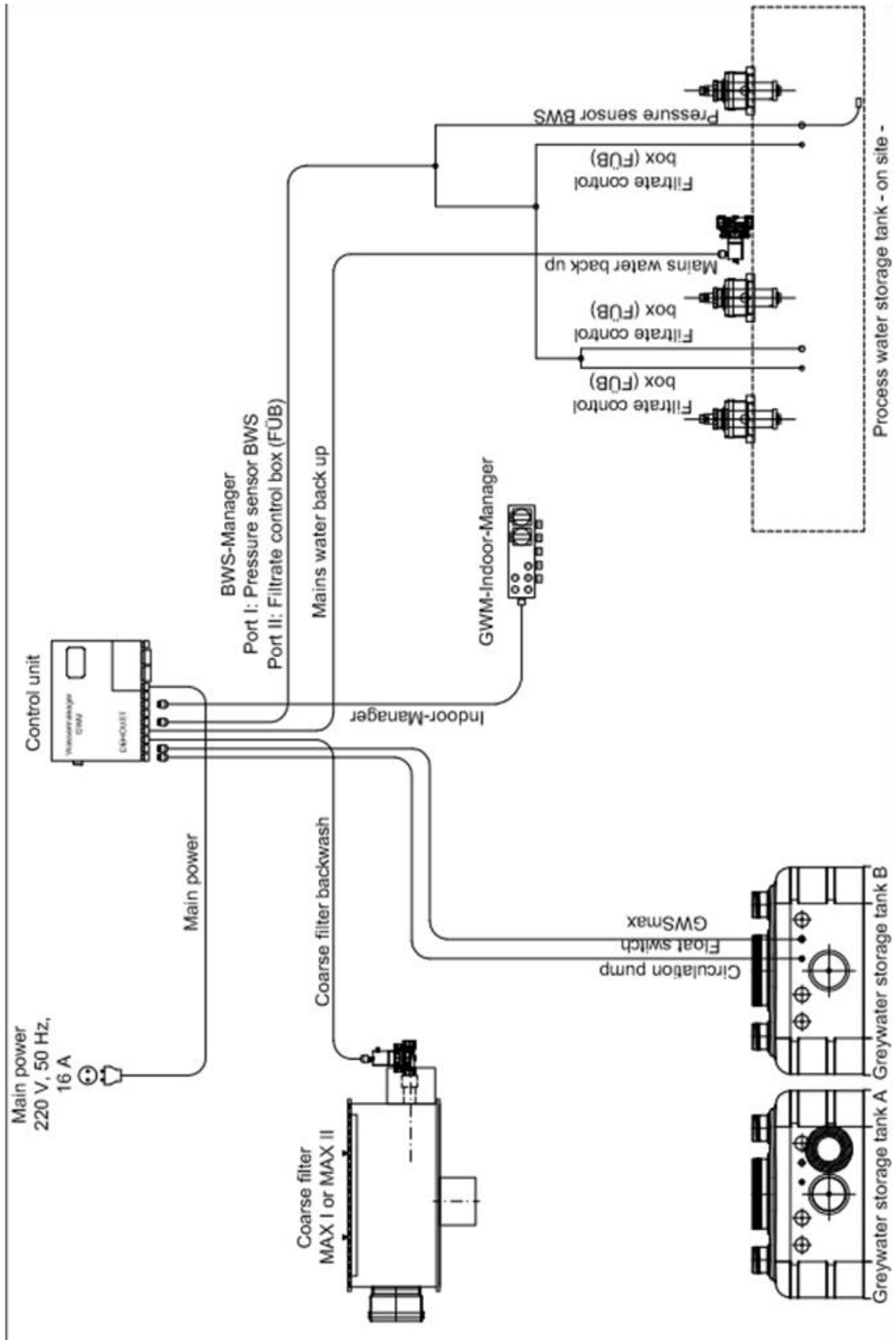

Figure 19: Electrical connection of coarse filter, greywater buffer tank and on-site process water storage tank (possibility 2)

5.10.2. Electrical connection of BMT unit(s) and air compressor(s)

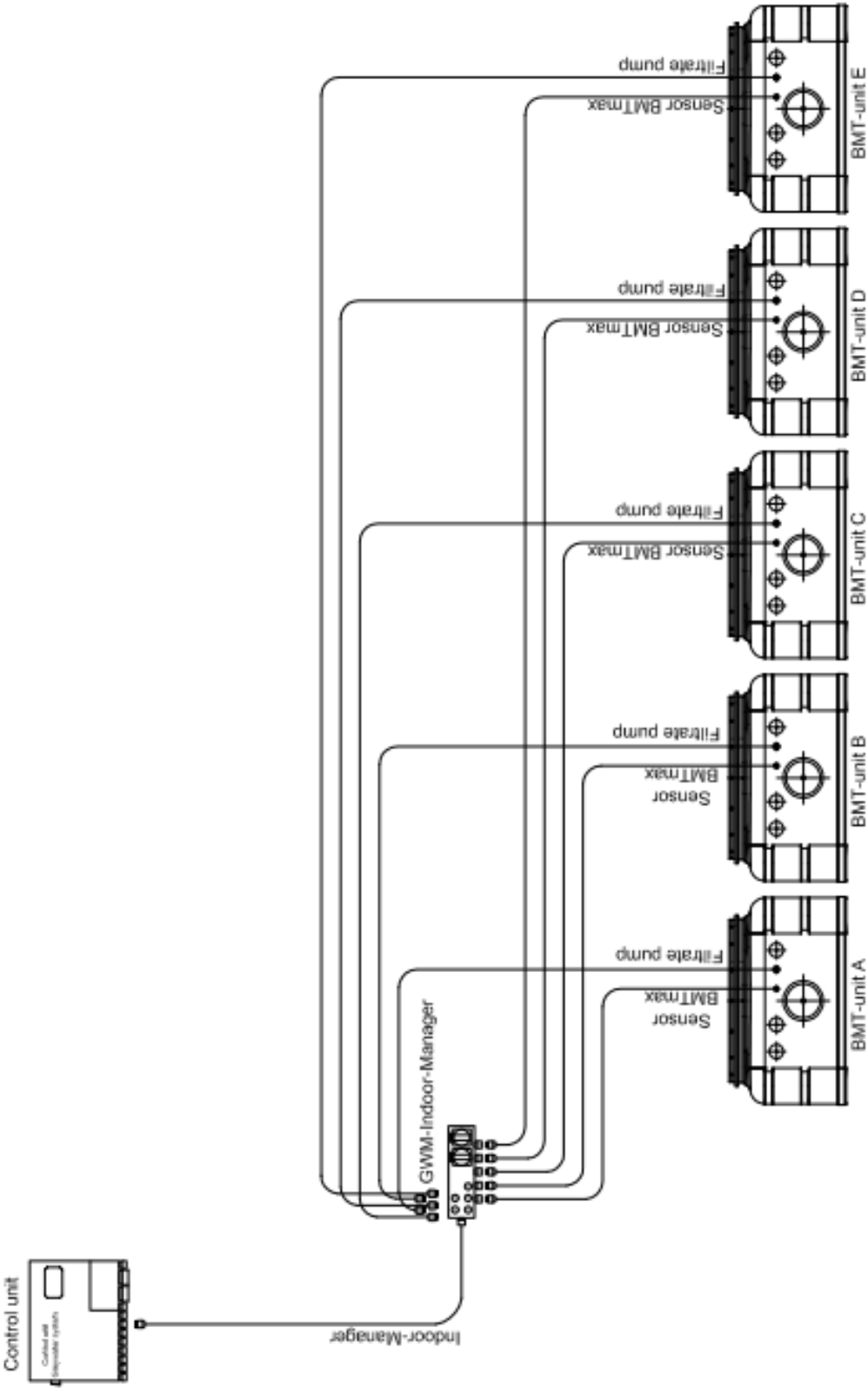

Figure 20: Electrical connection of GWM-Indoor-Manager with filtrate pumps and Sensors





The connection ports are labeled: BMT-unit A with connection port 1; BMT-unit B with connection port 2,...

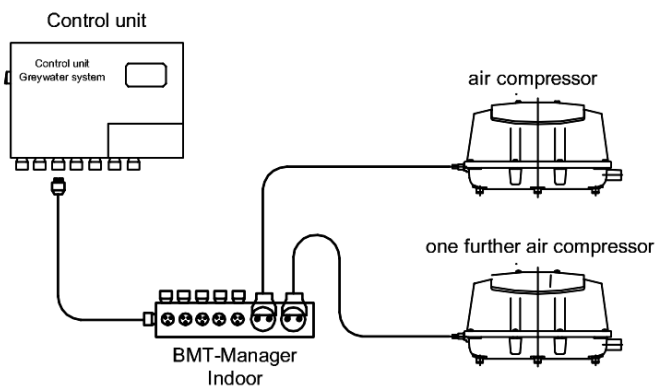

Figure 21: Connection of one to two air compressors to the BMT-Manager Indoor

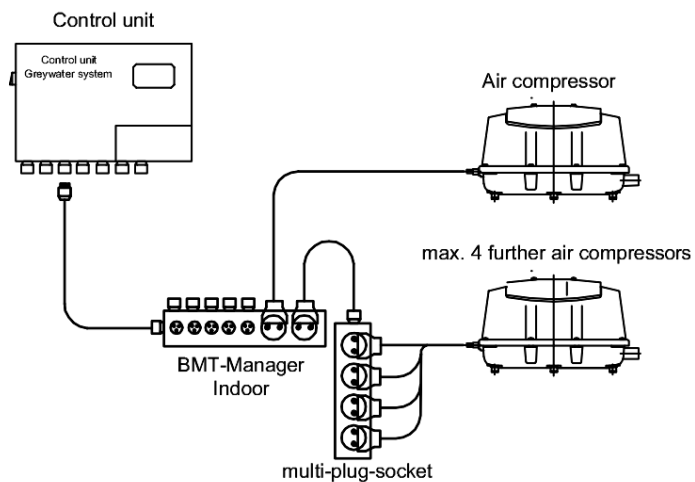

Figure 22: Connection of three to five air compressors to the BMT-Manager Indoor



The amount of filtrate pumps, BMT sensors and air compressors to be connected depends on the number of BMT units. A filtrate pump, BMT sensor and air compressor are connected to each BMT unit.

The number of BMT units depends on the type of system and can be between one and five BMT units.

## 5.11. Potential-free alarm output

It is possible for a general error message to be sent to a central control unit by connecting a potential free output (max. 230 V / 5 A) to the control unit. The error message output of the control unit has a break contact (open in case of alarm). The error message remains open until it has been manually deactivated in the control unit (please see *Operation manual GWM*).

The alarm contact is directly connected to the control unit. Please follow below steps:

- Switch off control unit from power supply.
- Remove the 6 allen screws (size 2) at the control unit to remove cover plate.
- Insert alarm cable through corresponding cable connection at the bottom side of the control unit (please see Figure 15).
- Connect alarm cable at following outputs at Crouzet controller: **O2**. Please see Figure 23.
- Close control unit by mounting the cover plate (use the 6 allen screws).
- Switch on control unit.

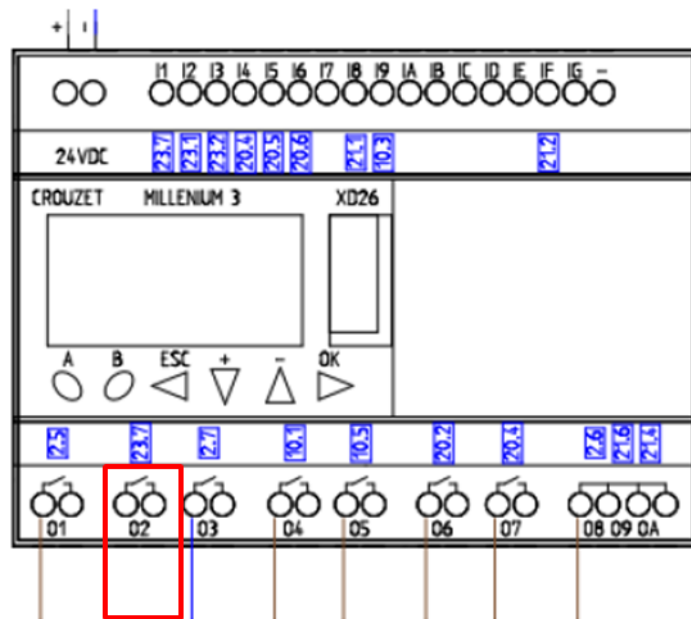

Figure 23: Connection of alarm output at Crouzet controller Output 2

## 5.12. Extern alarm input

It is possible to include an extern alarm sign (24 VDC) via potential free output to the control unit. The error message output of the control unit has a break contact (open in case of alarm). The error message remains open until it has been manually deactivated in the control unit (please see *operation manual GWM*).

The alarm contact is directly connected to the control unit. Please follow below steps:

- Switch off control unit from power supply.
- Remove the 6 allen screws (size 2) at the control unit to remove cover plate.
- Insert alarm cable through corresponding cable connection at the bottom side of the control unit (please see Figure 15).
- Connect extern alarm cable at following inputs at Crouzet controller: **24VDC+ and I1**. Please see Figure 24..
- Close control unit by mounting the cover plate (use the 6 allen screws).
- Switch on control unit.

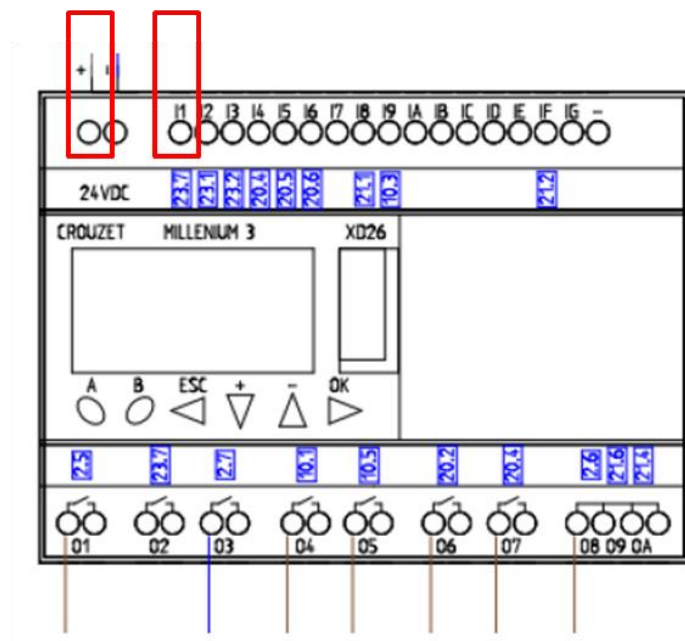

Figure 24: Connection of external alarm input at Crouzet controller input 24VDC+ and Input 1.



The extern alarm input needs to be activated at the control unit. For activation please heed the corresponding *Operation manual GWM*.

## 6. Commissioning

Only allow qualified personnel to commission the system (see 1.6).

The commissioning of the Watermanager GWM has to be done in **four steps**:

**Step 1:** Commissioning at MainsWaterMode (control unit set to *Mains-water*) – without connection to the greywater downpipe (bypassing) – avoid entering greywater into the greywater-reuse-system. Filling of greywater tanks and BMT-units with mains water. The automatic mains water back up system at the process water storage tank and the booster pump station are running with mains water for water supply. It is recommended to remain with this operation state until all construction works at the building are finished.

**Step 2:** After all construction works at the building have been finished the greywater downpipe is connected to the greywater-reuse-system. When at least 25% of the building residential capacity has been reached the greywater tank is inoculated with wastewater bacteria. It takes about 2 weeks until a strong wastewater bacteria culture has developed to treat greywater successfully. The operation mode remains during that time still in *Mains-water*.

**Step 3:** Commissioning to Automatic-Operation.



**Step 4:** Control of filtration performance after 4 weeks of operation.

### 6.1. System operation until commissioning

We do not recommend connecting the greywater inlet permanently with the system if building works are still being carried out in the building (**step 1**). We recommend installing a bypass of the greywater line directly into the sewer for this period. Only upon commissioning of **step 2** should the greywater inlet line be fixed to the system.

Before commissioning the *Watermanager GWM*, you must ensure the following points:

- The *Watermanager GWM* is electrically connected to all safety equipment according to the regulations.
- The relevant VDE and country-specific regulations have been complied with and fulfilled.
- Coarse filter inlet, overflow and drain are connected. Greywater inflow need to be connected by step 2.
- Greywater inlet and overflow lines are connected.
- Coarse filter backflow is connected to the process water network.
- Drinking water feed is connected to the drinking water network.
- Process water connection is connected to the process water line.
- Hose lines for greywater circulation, ventilation and filtration are connected.
- Discharge valves are connected to tanks.
- System is electrically connected as per regulations.





	<p>Take care that even in <b>step 1</b> the greywater tanks and BMT-units are filled up with mains water during the <i>Mains-water</i> operation. During <i>Mains-water</i> operation the greywater is circulating between greywater tanks and BMT-units as well as the BMT-units are ventilated by the air compressors. Without mains water in the tanks the operation will lead to severe damages at the components (pumps, air compressor).</p>
	<p>After first contact with water the BMT-membrane filter needs to be submerged all time in water. After dry-out the BMT-membrane filter is irreversible damaged.</p>

## 6.2. Step 1: commissioning to mains water – without greywater inflow

The Watermanager GWM should be operated in this state until all building works are finished. We do not recommend connecting the greywater inlet permanently with the system if building works are still being carried out in the building. We recommend installing a bypass of the greywater line directly into the sewer for this period.

Step by step commissioning:

- I. The greywater line is not connected to the coarse filter Trident, no greywater is entering the greywater tanks.
- II. Greywater buffer tank must be completely empty and clean. If necessary, pump out any stagnant water from the greywater buffer tank into the drain. Manually fill the greywater buffer tank one-third full with drinking water using a hose.
- III. BMT-unit must be completely empty and clean. If necessary, pump out any stagnant water from the BMT-unit into the drain. If the BMT-membrane filter was only partly submerged in water please contact immediately your contractual partner or DEHOUST.
- IV. Fill up BMT-unit with mains water until the mains water is flowing back to the greywater tanks.
- V. Connect the control unit with main power supply.
- VI. Switch on control unit.
- VII. Switch into mains water operation (*Mains-water*) by pressing the function key (A) at the control unit.
- VIII. Mains water back up system starts automatically and refill the process water storage tank.
- IX. De-aeration of each BMT-membrane filter by using a vacuum-handpump.
- X. Switch to Automatic-operation (*Automatic*) by pressing the function key (A) at the control unit.
- XI. One-off manual set-up of the filtration capacity on the PVC filtrate tap of each BMT unit according to the predefined maximum filtrate drain (see sticker attached directly to the PVC filtrate tap).
- XII. Switch into mains water operation (*Mains-water*) by pressing the function key (A) at the control unit.
- XIII. Open a process water consumer (e.g. toilet flush, tap). Close the process water consumer when water is discharged without air pockets.
- XIV. The system is ready to operate in mains-water-operation.

	On this step the process water consumers will be served via the mains water back up system and not with recycled greywater.
	Heed the <i>operating manual GWM!</i>
	Heed the <i>manual for manual BMT-membrane filter exchange and software update</i>
	Heed the manual for the booster pump station!
	During <i>Mains-water</i> operation the greywater is circulating between greywater tanks and BMT-units as well as the BMT-units are ventilated by the air compressors. Without mains water in the tanks the operation will lead to severe damages at the components (pumps, air compressor).

### 6.3. Step2: commissioning to mains water with greywater inflow

The *Watermanager GWM* should be operated in drinking water mode until the building has an occupancy rate of at least 25%. Efficient bacteria culture only develops in the *Watermanager GWM* when greywater is supplied daily in a sufficient volume.

The steps explained in the previous chapter (see 6.2) must have been complied in advance.

- I. Check sieve plate of coarse filter and remove all residues and waste.
- II. connect the greywater inlet with the coarse filter
- III. Put activated carbon and dry bacteria into the greywater buffer tank.
- IV. Run system for next 2 weeks in this mains-water-mode to establish a strong bacteria culture.



The wastewater-typical microbiology is established independently within 1 to 1½ weeks with continual greywater inlet. Until then, deviations can occur in the biological cleaning capacity.

### 6.4. Step 3: commissioning to automatic-operation

After a strong wastewater-typical microbiology is established the system can be turned into automatic-operation.

The steps explained in the previous chapter (see 6.3) must have been complied in advance.

- I. Manual switch into automatic mode by pressing the function key (A) at the control unit.
- II. System automatically switches to recycling mode and carries water to the process water storage tank after the relaxing time for membrane cleaning is over and if the fill level of greywater buffer tank displays “full” and the process water storage tank is not completely filled up.
- III. One-off manual set-up of the filtration flow rate on the Tacosetter at each single BMT-unit according to the predefined maximum filtrate flowrate (see sticker attached directly to the Tacosetter). Control the filtration flowrate by visible check at the Taccosetter. Please see Figure 25.
- IV. If necessary de-aerate once again each membrane filter with a hand-vacuum-pump until you don't see any bubbles in the filtered water.
- V. The system is ready to operate.

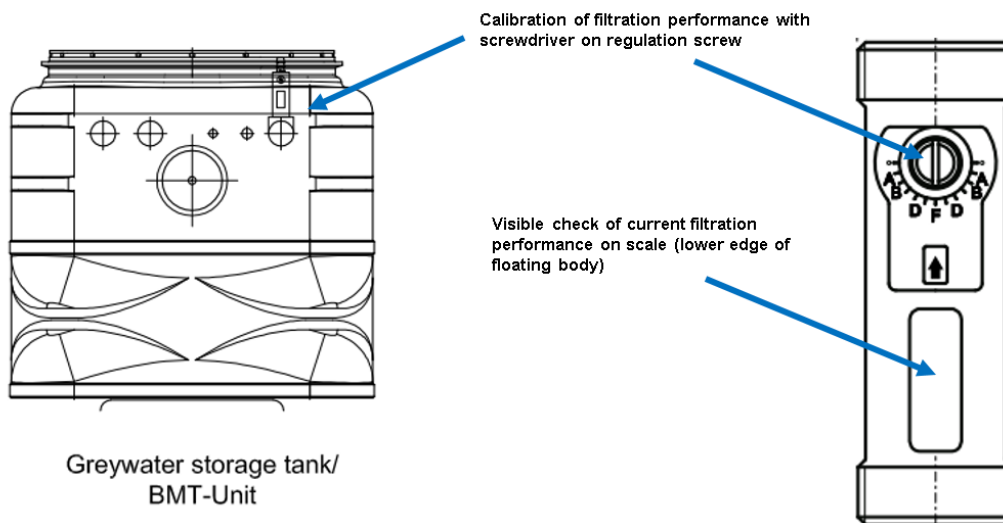

Figure 25: Set-up of filtration performance at Tacosetter

<b>i</b>	The higher the filtration capacity on the Tacosetter of the BMT unit is set, the higher the treatment capacity of the entire system and the lower the service life of the BMT membrane filter.
<b>i</b>	The wastewater-typical microbiology is established independently within 1 to 1½ weeks with continual greywater inlet. Until then, deviations can occur in the biological cleaning capacity.

## 6.5. Extended periods of downtime

The continual biological treatment of greywater by wastewater-typical microorganisms is maintained through the regular supply of greywater. If no greywater is introduced over an extended period of time (e.g. holiday, seasonal operation), then the number of microorganisms reduces. After fresh inlet of greywater, the microorganisms require a little time to achieve the maximum biological capacity. During this time, a reduced biological cleaning capacity can occur during the treatment process. Weak residual scents of shampoo, soaps, etc. may be subjectively noticed in the process water.

If the downtime of the system is longer than 4 weeks, then we recommend a supporting inoculation of microbiology with dry bacteria when the treatment process is recommenced.

	Please do not switch of the control unit during a downtime period to keep a sustain and strong microbiology. Please contact your contractual partner or DEHOUST.
--	---------------------------------------------------------------------------------------------------------------------------------------------------------------------

## 7. Repairs

The *Watermanager GWM* contains components, which require inspections and maintenance works.

- Inspections should be carried out by the operator of the system.
- Maintenance and repairs should only be carried out by qualified specialists (see 1.9).



It is in the operator's best interested to take note of the stated intervals for inspection and maintenance measures and the described work steps.

### 7.1. Inspections

If an inspection yields faults/damage in the *Watermanager GWM*, then you should contact your contracting party or DEHOUST.

#### 7.1.1. Trident coarse filter screen plate

To inspect the screen plate, the lid of the casing (secured by 4-6 wing screws) of the coarse filter is opened. Remove any stubborn, coarse impurities, which could not be removed by the spray nozzles, from the screen plate using a cleaning brush. Dispose of the filter residue in the residual waste.

Time frame: Quarterly



Avoid direct skin contact with the filter residue (wear rubber gloves) when cleaning the screen plate.

#### 7.1.2. Trident coarse filter solenoid valve

Check the solenoid valve to the backwash for impermeability and function. To do this, directly activate and disable the solenoid valve in manual mode (see **Fehler! Verweisquelle konnte nicht gefunden werden.**) in the firmware set-up.

Time frame: Quarterly

#### 7.1.3. Drinking water feed solenoid valve

Check the solenoid valve to the drinking water feed for impermeability and function. To do this, open the process water consumer and wait until the fill level in the process water storage tank has fallen so that the solenoid valve is open. Reclose the process water consumer and wait until the solenoid valve recloses.

Time frame: Quarterly

#### 7.1.4. Check hose and water connections



Check all hose connections (circulation, air compressor, filtration) and drinking water and process water connections for damage, impermeability and porous or worn patches. If necessary, replace and reseal hoses/lines.

Time frame: Quarterly

### 7.1.5. Check air compressor

Check and if necessary replace the airfilter of each air compressor according to following figure.

Time frame: quarterly

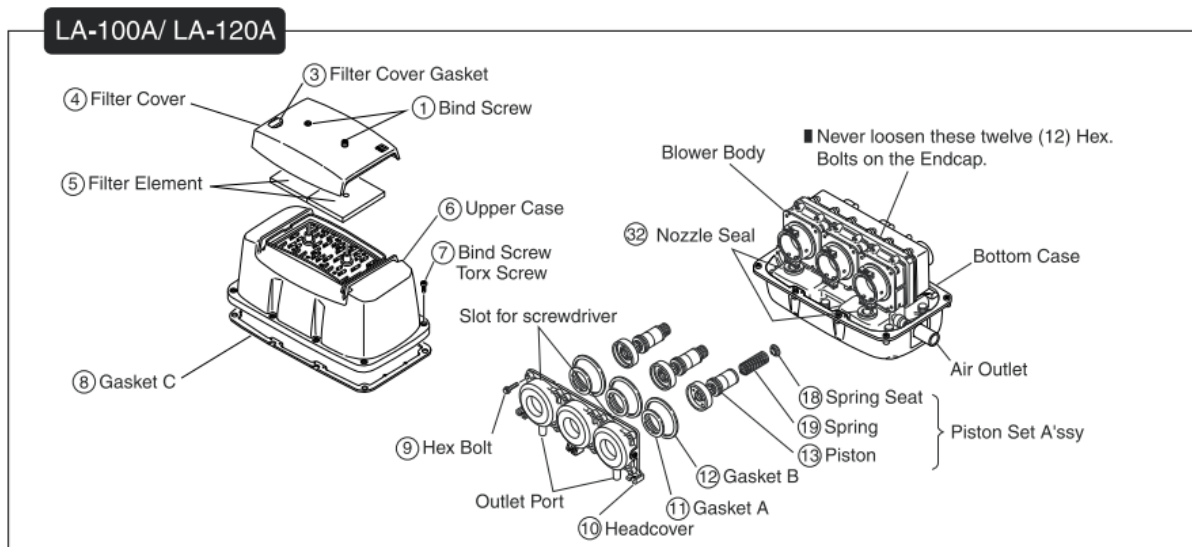

- I. Disconnect air compressor from electricity grid (power supply).
- II. Loose screws (1) and remove cover plate (4).
- III. Remove air filter (5) from chassis (6) and put a new air filter into it.
- IV. Clean air inlet at cover plate (4) and top of cover (6).
- V. Install cover plate (4) correctly at filter cover plate (6).
- VI. Install cover plate (4) at top of cover (6) by tighten the screws (1).

### 7.1.6. Function of the pressure booster

<b>i</b>	Heed the inspection intervals in the operating and installation guide for the pressure booster as well!
----------	---------------------------------------------------------------------------------------------------------



## 7.2. Maintenance

The operating hours of the air compressor(s) are essential for the maintenance intervals. After a run time of 16,000 operating hours (approx. 20 months of operation), the message "Maintenance" (see *operation manual GWM8.1*) is shown on the control unit display. A contracting party or DEHOUST has to carry out the maintenance and to reset the operating hours meter.

The filtration performance of the BMT-membrane filters depends on the greywater composition, the real daily treatment performance and the real consumption for process water. For these reasons it may happen that one or more BMT-membrane filters have to be exchanged before the regular maintenance interval.

The exchange of one or more BMT-membrane filters has to be done by a contracting party or DEHOUST. Please heed the corresponding *manual for BMT-membrane filter exchange and software update*.

The maintenance is carried out allowing for and following the instructions of the maintenance log for greywater systems!

	Disconnect the <i>Watermanager GWM</i> from the electricity grid during maintenance and repair work.
	Heed the <i>operation manual GWM</i> as well!
	Heed the <i>manual for BMT-membrane filter exchange and software update</i> as well!

## 8. Errors/Troubleshooting

### 8.1. Errors displayed at the control unit

Please heed the operation *manual GWM* for error messages that are displayed at the control unit.



### 8.2. Pressure surges in drinking water line

The solenoid valve does not open abruptly. It opens gently through a servo-controlled membrane. This normally prevents pressure surges in the drinking water line. Pressure surges occur if pressure differences greater than 2 bar exist between the standing pressure and flow pressure.

If a shut-off valve or pressure reducing valve is installed in the drinking water line upstream of the system, this must be restricted until the pressure surge has disappeared when opening the solenoid valve. The disadvantage of this method is a low feed volume. You must check whether the feed volume is still sufficient for normal process water consumption. In doing so, the fill level in the process water storage tank must not fall so low that the pressure booster is switched to dry run protection. If the pressure booster still switches to dry run protection, then the pressure side must also be reduced.

### 8.3. Odours in the installation room/at the consumers

The oxygen supply by the air compressor for biological treatment is too low or possibly interrupted. Please check the hose connections (see 7.1.4) and operating parameters for air compressor/circulation/filtration (see *operation manual GWM*) and adjust/increase as required.

	It is not always possible to completely avoid a slight greywater odour in the installation room or process water. As such, this is not considered an odour nuisance as such.
	We recommend a separate (roof) ventilation line for the greywater buffer tank (see 5.4).
	Heed the <i>operation manual GWM</i> as well!

## 9. Disposal

The packaging material should be recycled as wastepaper.

The product should be sent free of charge to the manufacturer, DEHOUST GmbH.

## 10. Declaration of Conformity

**EC Declaration of Conformity**  
**in the sense of the EC**  
**Electromagnetic Compatibility Directive 89/336/EEC**  
**Low Voltage Directive 73/23/WEG**  
**Machinery Directive 89/382/EEC**

We hereby declare that the appliance stated below conforms to the pertinent and fundamental requirements of the EC Directives in terms of its design and construction.

**Product description:** Dehoust - greywater usage

**Type designation:** Watermanager GWM

Applied standards:

EN 292-1; EN 292-2; EN 55014-1; EN 55014-2; EN 60204-1; DIN EN 50 081 Part 1; DIN EN 50 082 Part 1; DIN EN 60335; DIN 1988 Part 4; DIN EN 1717.

The following operating conditions and ambient conditions must be implemented:

The appliance is designed for the control/regulation and operation of a greywater treatment system.

The instruction manual and installation guide must be taken into account and followed.

DEHOUST GmbH  
Gutenbergstraße 5-7  
D- 69181 Leimen



ppa. Luciano Schildhorn

24.06.2022

Date/Signature of manufacturer

